



COCCHI



Mod. A 8 S

Aspirante - Soffiante -
Riscaldato
Vacuum - Blowing - Heated
Soufflante - Aspirante -
Chauffée

Mod. A 8

Aspirante - Riscaldato
Vacuum - Heated
Aspirante - Chauffée

Linea - Spring

Mod. E 5

Aspirante - Riscaldato
Vacuum - Heated
Aspirante - Chauffée

Mod. A8S-1 & Mod. A8-1

SENZA CALDAIA
WITHOUT BOILER
SANS CHAUDIERE

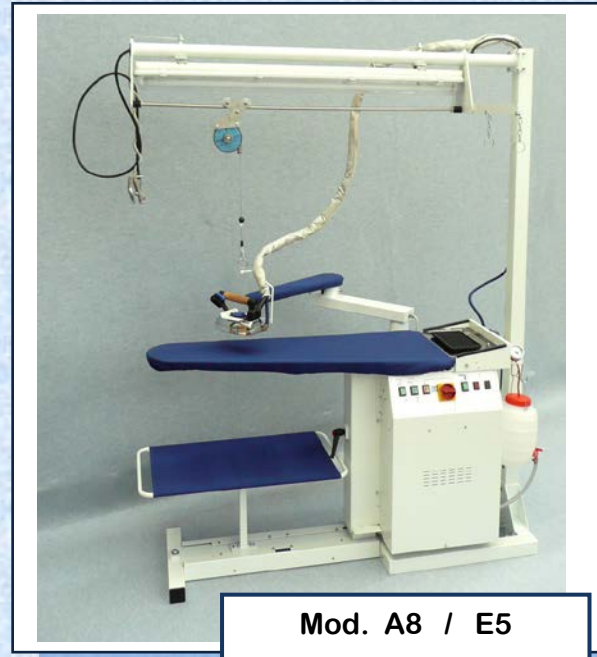

Mod. A8 / E5

Piano Stiro - Ironing Board - Plateau Travail

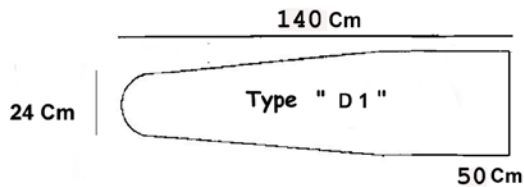

x Mod. A8 S

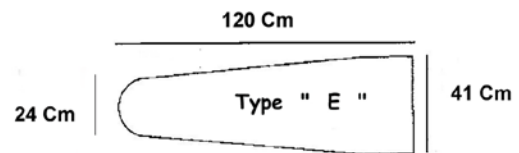

x Mod. A8 - E5

Alluminio

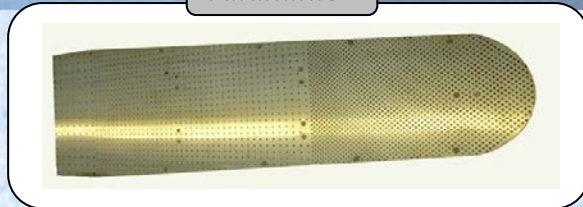

da 88 a 107 cm



TUTTO ALTO - ALL HIGH - TOUT HAUTE Cm 107



TUTTO BASSO - ALL LOW - TOUT BAS Cm 88

Descrip.	Mod.	A8 S	A8	E5
Piano - Board - Plateau		Tipo D1	Tipo E	Tipo E
Resistenza Piano - Board Element - Resistance Plateau		1000 watt	1000 watt	1000 watt
CALDAIA - BOILER - CHAUDIERE in <i>INOX</i>		8 Lts	8 Lts	5 Lts
RESISTENZE CALDAIA BOILER ELEMENTS RESISTANCES CHAUDIERE		3600 watt 4700 watt	3600 watt 4700 watt	2600 watt 3600 watt
MOTORE ASPIRAZIONE - VACUUM MOTOR - MOT. ASPIRATION		no	0,5 Hp	0,5 Hp
MOTORE ASPIRAZIONE - SOFFIATURA VACUUM-BLOWING MOTOR MOTEUR ASPIRATION-SOUFFLERIE		0,5 Hp plus	no	no
FERRO STIRO - IRON - FER A REPASSER		Incl. (H1)*	Incl.Jolly	Incl.Jolly
RESISTENZA FERRO STIRO - IRON ELEMENT - RES. FER		900 watt	800 watt	800 watt
POMPA ACQUA - WATER PUMP - POMPE A EAU		0,5 Hp	0,5 Hp	0,5 Hp
TANICA ACQUA - WATER TANK - BIDON POUR L'EAU		opt.	opt.	serie
FOTOCELLULA PER ASPIRAZIONE PHOTOCELL FOR VACUUM PHOTOCELLULE POUR ASPIRATION		serie	opt.	opt.
DOPPI PEDALI PER STIRATURA DESTRA-SINISTRA DOUBLE PEDALS FOR LEFT & RIGHT IRONING-SIDE DOUBLES PEDALS POUR REPASSAGE DROITE & GAUCHE		opt.	opt.	opt.
POGGIAFERRO ANTERIORE MOBILE IRON REST FRONTAL-MOBILE REPOSE FER ANTERIEUR MOBILE		serie	opt.	opt.
BRACCIOLA MANICHE SLEEVES-ARM JEANNETTE MANCHE		opt.	opt.	opt.
BRACCIOLA INOX SMACCHIATURA A VAPORE INOX ARM FOR STEAM-SPOTTING JEANNETTE INOX POUR DETACHAGE A VAPEUR		opt.	opt.	opt.
PISTOLA VAPORE - ARIA - PISTOLA VAPORE AIR-STEAM GUN - STEAM GUN PISTOLET AIR-VAPEUR - PISTOLET VAPEUR		opt.	opt.	opt.
BRACCIO LUCE o BRACCIO LUCE E SOSPENSIONE FERRO LIGHT ARM or LIGHT ARM & IRON-SUSPENSION BRAS ECLAIRAGE ou BRAS ECLAIRAGE ET SUSPENT-FER		opt.	opt.	opt.
FERRO VAPORE - VAPORE e / o RECUPERATORE Cond STEAM - STEAM IRON and / or CONDENS. RECUPER. FER VAPEUR - VAPEUR et / ou RECUPERATEUR Cond		opt. Kg 1,3	opt. Kg 1,3	opt. Kg 1,3



COCCHI srl

via Pacinotti 19-A - 40017 San Giovanni in Persiceto - Bologna - Italy

tel. ++39 - 051 821787 fax ++39 - 051 826935

web site : www.cocchi.net e.mail : info@cocchi.net



P.E.D
97/23



INOX 5 Lts - Elettronica

INOX 8 Lts - Elettronica

PRESSIONE VAPORE 3 > 5 Bar
STEAM PRESSURE 3 > 5 Bar
PRESSION VAPEUR 3 > 5 Bar

H1 ERGONOMICO*



Kg 1,5 Elettrico - Electric 900 watt



Tanica Acqua a Controllo Elettronico del livello
Water Tank at electronic control of the level
Bidon pour l'Eau à controle electronique du niveau.

Opt. A8 - A8S

Serie. E5

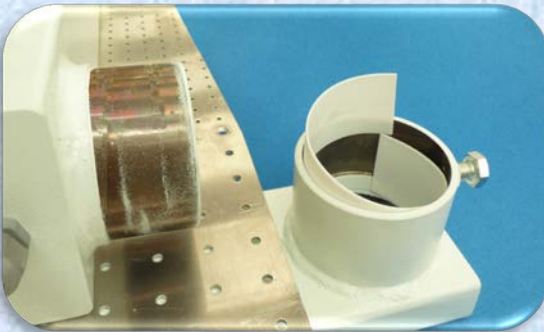

teflon anigrippaggio braccioli
teflon anti-seizure arms
teflon anti-grippage jeannettes

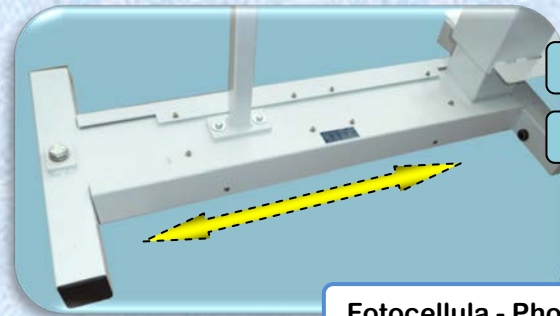

Opt. E5 - A8

Serie. A8S

Fotocellula - Photocell

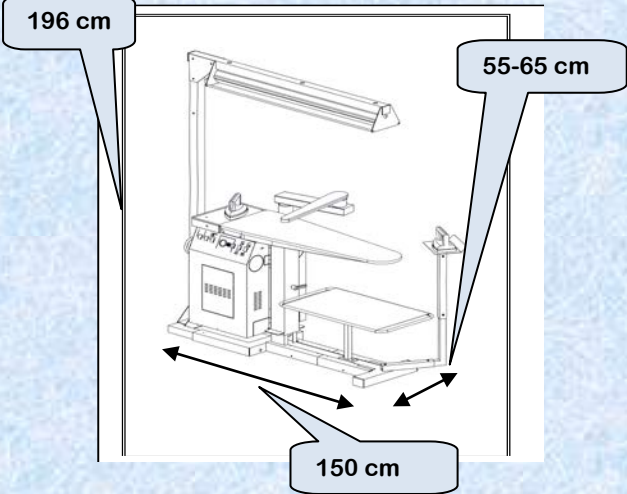

Serie. A8S Piano - Board - Plateau D1



140 cm

Opt. A8

